

50W H.F. TRANSMITTER

TYPE SFZ 395/00

**MANUAL
DB-R 1055e**



N.V. PHILIPS' TELECOMMUNICATIE INDUSTRIE

HILVERSUM - NEDERLAND

Property of
Eigentum der

Propriété de la
Es propiedad de la

Eigendom van

N.V. PHILIPS' TELECOMMUNICATIE INDUSTRIE
HILVERSUM - NEDERLAND

Reproduction or disclosure to
third parties, in any form
whatsoever, is not allowed
without written consent of
the proprietors.

La reproduction ou la communi-
cation à des tiers, sous quelque
forme que ce soit, n'est permise
qu'avec l'autorisation écrite de
cette Société.

Vervielfältigung oder Bekannt-
gabe an Dritte, in welcher
Form auch, ohne schriftliche
Genehmigung der Eigentümerin,
ist nicht gestattet.

Queda prohibida la reproducción
o comunicación a terceros, en
cualquier forma que sea, sin la
autorización escrita de la pro-
pietaria.

Vermenigvuldiging of mededeling
aan derden, in welke vorm ook,
is zonder schriftelijke toe-
stemming van eigenares niet ge-
oorloofd.

CONTENTS

	<u>Page</u>
INTRODUCTION	1
TECHNICAL SUMMARY	2
DESCRIPTION OF THE CIRCUIT	4
a. The transmitter section	4
b. The A.F. input circuit	6
c. The power supply section	8
d. The metering circuit	9
PHYSICAL DESIGN	9
INSTALLING INSTRUCTIONS	10
First alignment of the transmitter section	11
First alignment of the modulator section	13
DAILY OPERATION	14
a. Switching on	14
b. Transmitting	14
c. Switching off	14
TEST DATA	15
a. Continuity testing	15
b. Voltage testing	15
PARTS LIST	18
<u>DIAGRAMS</u>	
1. Circuit diagram	DB-R 1055e/1-1
2. Views	DB-R 1055e/1-2

ADDITION No. 1
TO MANUAL DB-R 1055e FOR
HF TRANSMITTER TYPE SF2 395/00

A. For item 4 of the "INSTALLING INSTRUCTIONS" read:

4. Using an 8-pole plug, connect the modulation line to the 8-pole socket at the back of the chassis on the left-hand side. Refer to the circuit diagram for the proper connection of the plug.

In the absence of a modulation line, when local control is used, connect the microphone and the push-to-talk switch to jack KL101 and the Morse key to jack KL102, as shown below in item B. In this case terminals 1 and 7 of socket CST1 should be interconnected.

B. Jacks KL101 and KL102 and the associated telephone plugs should be connected as per the Fig. below. The Fig. as such replaces the relevant section of diagram 1.

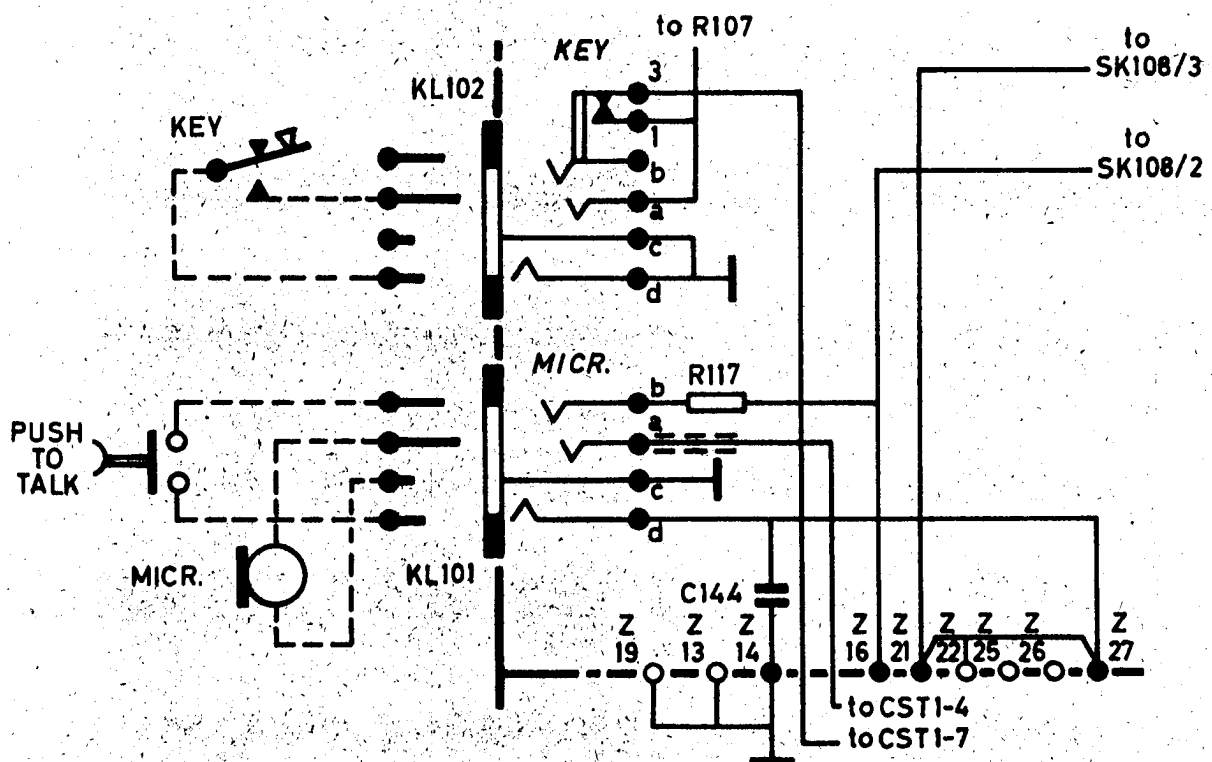

INTRODUCTION

Philips' 50 W H.F. transmitter, type SFZ 395/00, has been designed for telegraph (A1) and telephone (A3) signals. The transmitter is continuously tunable throughout the 1.5 to 30 Mc/s range. There is a minimum number of tuning elements on the front panel because wideband circuits are used in the R.F. preliminary stages.

In the above-mentioned frequency range a choice can be made of 18 crystal-controlled frequencies. The transmitter complies with the Radio Regulations of Atlantic City with respect to frequency stability in ambient temperatures between +10°C and +45°C.

It is also possible to employ an oscillator connected to the transmitter.

Modulation and remote control of the carrier (push-to-talk operation) are accomplished via a 2-wire telephone line.

The transmitter is housed on a single chassis and can be incorporated in a 19-in. cabinet.

It is suitable for operation in tropical climates.

INTRODUCTION

Philips' 50 W H.P. transmitter, type SFZ 395/00, has been designed for telegraph (A1) and telephone (A3) signals. The transmitter is continuously tunable throughout the 1.5 to 30 Mc/s range. There is a minimum number of tuning elements on the front panel because wideband circuits are used in the R.F. preliminary stages.

In the above-mentioned frequency range a choice can be made of 18 crystal-controlled frequencies. The transmitter complies with the Radio Regulations of Atlantic City with respect to frequency stability in ambient temperatures between +10°C and +45°C. It is also possible to employ an oscillator connected to the transmitter.

Modulation and remote control of the carrier (push-to-talk operation) are accomplished via a 2-wire telephone line.

The transmitter is housed on a single chassis and can be incorporated in a 19-in. cabinet.

It is suitable for operation in tropical climates.

TECHNICAL SUMMARY

Frequency range

1.5 to 30 Mc/s

Crystal frequencies

1.5 to 10 Mc/s. Six crystals may be fitted in the transmitter.

Frequency stability

better than 3×10^{-7} at an ambient temperature of +10°C to +45°C

R.F. power output

approx. 50 W to the aerial

Harmonics and spurious radiation

better than -40 dB and -60 dB respectively

Output impedance

50 - 75 ohms unbalanced

Standing-wave ratio

max. 1 : 2

Modes of operation

A1 : telegraphy
A3 : telephony

Keying speed

max. 50 bauds for A1

A.F. input impedance

approx. 600 ohms balanced for the telephone line
approx. 100 ohms for the carbon microphone

A.F. response

+ 3 dB with respect to 1000 c/s, from 250 c/s to 5000 c/s
at 80% depth of modulation

A.F. input level

telephone line: variable to a minimum of -8 dBm
carbon microphone: 100 mV across 100 ohms

Non-linear distortion

less than 8% between 250 c/s and 5000 c/s at 90% depth of modulation

Maximum depth of modulation

approx. 100%

Hum and noise level

better than -40 dB at 100% depth of modulation

Ambient temperature

+10° to +45°C at an altitude of 1800 m: max. +30°C

Relative humidity

max. 95%

Mains voltage

110 or 220 V $\pm 5\%$, single phase, 50-60 c/s $\pm 5\%$

Power consumption

at no load (stand-by) : max. 120 W ($\cos \varphi = 0.82$)
at 95% modulation : max. 420 W ($\cos \varphi = 0.95$)

Tube complement

transmitter section	:	3 x E80L
		1 x QQE 06/40
modulator section	:	1 x E80L
		1 x QQE 06/40
power supply section	:	3 x GZ34

Dimensions:

height	:	approx. 221 mm
width	:	approx. 483 mm
depth	:	approx. 500 mm

Weight

approx. 40 kg

DESCRIPTION OF THE CIRCUIT

(see diagram 1)

The transmitter consists of:

- a. a transmitter section
- b. an A.F. input section
- c. a power supply section
- d. a metering circuit

a. The transmitter section

This section is equipped with tubes B101 to B103 (type 680L) and tube B104 (type QQE 06/40).

Tube B101 is circuited as a Colpitts oscillator. Switch SK101 "CRYSTAL SWITCH" permits a choice to be made of 6 crystals. With this switch set to position 7 "EXTERN", tube B101 is circuited as an amplifier for an external variable frequency oscillator.

Six trimmers (C147 to C152), by means of which the adjustment to the nominal frequency is made, are connected in parallel to the crystals.

In the inoperative condition of the transmitter, a potential of approx. -45 V is applied to the control grid of tube B102. During keying (MARK) the control grid is earthed and the tube made conductive. Consequently, in A1-operation this tube is employed as keying stage. The anode impedance of the tube consists of coil L102. This coil, together with the tube capacities, is tuned to a frequency of 0.85 Mc/s.

Depending on the required aerial frequency, tube B103 operates as a straight amplifier, a doubler or a tripler. A drive signal of adequate strength for use of the tube as a doubler or tripler is obtained by connecting an inductively coupled bandpass filter between the anode of tube B102 and the control grid of tube B103. The filter has a bandwidth of 4.5 to 10 Mc/s, which corresponds to frequency ranges 5 and 6, which cover 9 Mc/s to 30 Mc/s. In the four lower ranges, switch SK104 short circuits the bandpass filter.

It is shown by the above that the highest crystal frequency required for an aerial frequency of 30 Mc/s is 10 Mc/s. The gain of tube B103 is controlled by varying the screen grid voltage with potentiometer R115 "DRIVE".

The grid circuit of output tube B104 consists of tunable circuit C117 - L105 - L106. The circuit is tuned by means of the "GRID TUNING" control on the front panel. In the four higher frequency ranges, portions of these coils are short circuited by means of switch SK105. The circuit is tuned with the help of meter ME101 with switch SK111 set to the "P.A. I_g" position. In order to prevent errors in tuning, tuning capacitor C117 "GRID TUNING" has a pointer which runs over a roughly calibrated scale. This is the lower of the two scales on the front panel.

Anode-screen grid modulation is employed in the output tube. For this purpose the screen grids are fed via coil L18 and the anodes via the secondary of modulation transformer T3. The anode circuit of output tube B104 consists of a π -filter. This filter provides matching between the anode impedance and the aerial load of 50 ohms. The anode circuit is tuned by means of capacitors C124-C125-C126 "ANODE TUNING", which are mechanically coupled. Proper matching to the aerial is achieved by means of capacitors C129 to C133 and C140, C141 and C142. Just like capacitor C117, capacitors C124-C125-C126 are provided with a pointer which runs over the upper scale on the front panel. This scale too is roughly calibrated. The circuit is tuned by means of variable capacitor C129 ("AERIAL TUNING"), whilst, depending on the required frequency, more or fewer capacitors are connected in parallel to capacitor C129. This is done in eight steps, as is indicated by a numeral beside the "AERIAL TUNING" control.

So as to be able to cover the 1.5 - 30 Mc/s frequency range completely, the relevant coils and capacitors are switched in six steps. This is done by means of the "RANGE" control, which is mechanically coupled with switches SK104, SK105, SK106, SK107 and SK109.

The frequency range is divided into the following sub-ranges:

1	1.5 Mc/s - 2.0 Mc/s
2	2.0 Mc/s - 2.5 Mc/s
3	2.5 Mc/s - 5.0 Mc/s
4	5.0 Mc/s - 9.2 Mc/s
5	9.2 Mc/s - 17.5 Mc/s
6	17.5 Mc/s - 30.0 Mc/s

The negative grid bias for output tube B104 is taken from the relevant voltage source and applied to the transmitter section via terminal Z1.

The cathode circuit of tube B104 contains meter ME102 "CATHODE CURRENT P.A." which is used in tuning the output stage. The cathode current is approx. 170 mA (8.5 scale divisions) for an output power of 50 W.

The aerial current can be measured by means of meter ME101 and with metering switch SK111 set to the "I ANT." position. For this purpose, the R.F. output voltage is first rectified by circuit C42 - GR1 - R21. This circuit is capacitively coupled (C41) with the aerial. The aerial has to be connected to coaxial socket ST4 at the back of the transmitter.

The reduced output power required for tuning is obtained by setting switch SK108 to the "TUNE" position and thereby energizing relay RE102. The relay then causes voltage divider R124-R131 to be

switched into the screen grid circuit.

b. A.F. input circuit

As the transmitter can be operated by local control or by remote control, both for A1 and A3, the two methods will be discussed separately.

A3-operation

Remote control

Two methods may be employed, i.e. by means of a remote control station or by means of a microphone with push-button.

Remote control station

The remote control station should be arranged in such a way that a negative direct voltage (16 - 48 V) can be applied to the transmitter via the modulation line by operating a switch. It is shown in diagram 1 in broken lines.

The circuit operates as follows:

Via a screened 2-conductor cable, the A.F. signal is taken to terminals 2 and 3 of ST1 and from there to primary windings 5-6 and 7-8 of transformer T1 which are connected in series. The screening of the above cable is connected to the chassis via terminal 1 of ST1. The negative direct voltage energizes relay RE4, again via the above-mentioned primary windings and via the interconnected terminals Z27 and Z21.

Make contact re4-1 switches on the primary voltage of transformer T4, after which the transmitter is ready for use.

Switch SK108 is at the "ST.-BY" position, whilst switch SK111 should be at one of the positions 4, 5, 6 or 7.

Terminal 7 of SK1 should be earthed.

Microphone with push-button ("push-to-talk" switch)

The microphone is connected to terminals 1 and 4 and the "push-to-talk" switch to terminals 5 and 6 of ST1.

Terminal 1 is connected to the chassis. When the push-button is operated, the voltage of -35 V taken from rectifier GR3 is applied to relay RE4 via terminals 5 and 6 and the interconnected terminals Z27 and Z21.

The A.F. signal is applied to winding 1-2 of transformer T1 via terminal 4. The microphone voltage is a voltage of -3 V which is taken from capacitor C57 and which is also applied to winding 1-2 of transformer T1.

In this case too, switch SK108 should be at the "ST.-BY" position, whilst switch SK111 should be set to one of the positions 4, 5, 6 or 7.

Terminal 7 of ST1 should be earthed.

Local control

If the transmitter is operated by local control, the microphone with push-to-talk switch is connected to jack KL101 in such a way that the microphone is connected to terminals a and c, and the push-to-talk switch to terminals b and d of this jack. Via terminals a and c, the A.F. signal is applied to windings 1 and 2 of transformer T1. Terminal c is connected to the chassis.

The microphone voltage is again the -3 V, this time it is applied to terminal a via winding 1-2. The energizing voltage of relay RE4 is applied to this relay via terminal Z16, resistor R117, the push-button switch and the interconnected terminals Z27 and Z21. Just as in the two applications mentioned before, switch SK108 should be at the "ST.-BY" position and switch SK111 at one of the positions 4, 5, 6 or 7. Terminal 7 of ST1 has to be connected to earth.

A1-operation

Remote control

The Morse key is connected between terminal 7 of ST1 and earth. With the key on mark, the -45 V control grid voltage of tube B102 is earthed. The tube is thereby made conductive for the crystal frequency. With switch SK108 set to the "TRANSMISSION" position, relay RE4 is energized via terminal Z16, switch SK108 and terminal Z21.

Switch SK111 is set to position 1, 2 or 3.

Local control

The Morse key is connected to jack KL102, i.e. to terminals a and d. Terminal d is connected to the chassis, so that, just as with remote control, the control grid of tube B102 is earthed when the key is on mark.

Relay RE4 is energized again by setting switch SK108 to the "TRANSMISSION" position. Switch SK111 has to be set to position 1, 2 or 3.

The modulator section

The A.F. signal, derived from secondary winding 3-4 of input transformer T1, is applied to amplifier tube B6 via potentiometer circuit R32-R35. The required depth of modulation can be adjusted from the front panel by means of potentiometer R32 "MODULATOR".

The anode circuit of tube B6 consists of transformer T2. The amplified signal is taken from the secondary of this transformer and applied in push-pull to tube B7. This tube is a twin tetrode which is circuited as a push-pull amplifier and operated under class-B conditions.

The necessary adjustments are made with the help of potentiometer R52.

The anode circuit of tube B7 consists of the primary of transformer T3; feedback being provided via tappings 4 and 6 on this transformer.

The A.F. signal produced across secondary 1-2 of transformer T3 is connected in series with the anode voltage of transmitter output tube B104.

The secondary is short circuited when switch SK111 is at the positions "P.A.Ig", "I ANT." and "C.W."

At these positions of the switch, the transmitter is used for A1-signals.

The cathode current of tube B7 can be measured by means of meter ME101 with switch SK111 set to the "Ik MOD." position.

c. The power supply section

The power supply voltages are derived from a 220 V or 110 V mains with a frequency of 50 or 60 c/s.

The circuit diagram shows how the primary windings of transformers T4 and T5 should be connected for either mains voltage.

For 110 V the primaries of each transformer are connected in parallel, whilst they are connected in series for 220 V.

The transmitter is protected by fuse VL1 (4 A) for a 220 V mains or VL2 (8 A) for a 110 V mains.

The transmitter is switched on by means of SK4 "MAINS".

Connected to the series-circuit of secondary windings 11-12 and 13-14 is Graetz-circuit GR3 which produces a voltage of -35 V.

This voltage is used for energizing transmitting relay RE4.

Connected to the secondary winding 5-6 of transformer T5 are pilot lamp LA1 and the filaments of all tubes.

If transmitting relay RE4 is energized, contact re4-1 switches transformer T4 into circuit. The series-circuit of capacitor C59 and resistor R57 has been fitted to damp the peak voltages caused by switching the transmitter on.

The voltage on secondary winding 5-8-11 of transformer T4 is rectified by tubes B8 and B9 (type GZ34).

The direct voltage of 550 V thus obtained is smoothed by the filter consisting of C151 - L120 - C52 and it is used for the anode supply of tubes B7 and B104.

The voltage across the secondary winding 6 - 8 - 10 of transformer T4 is rectified by tube B10 (type GZ34).

This voltage (250 V) is smoothed by filter C53 - L21 - C54 and used as screen grid voltage for tubes B7 and B104, and as anode and screen grid voltage for tubes B6 and B101 to B103.

The voltage across winding 7 - 8 - 9 is rectified by rectifiers GR2. The negative direct voltage (-45 V) thus obtained is smoothed by filter C55 - L22 - C56 and then used for operating tubes B7 and B102 to B104.

Having passed through voltage divider R51 - R53, the voltage across capacitor C57 has a value of -3 V. It is used as the carbon microphone voltage.

d. The metering circuit

The transmitter is equipped with two meters: ME101 and ME102. "CATHODE CURRENT P.A."

Meter ME101 is switched into the various circuits by means of switch SK111, as per the table below:

POSITION of SK111	CURRENT MEASURED	RANGE
P.A. Ig I. ANT. C.W. PHONE	grid current B104 aerial current	10 mA
I. ANT. P.A. Ig Ik. MOD.	aerial current (modulated) grid current B104 (modulated) cathode current B7	10 mA 200 mA

At the first three positions, the secondary winding of modulation transformer T3 is short circuited by the third wafer of switch SK111. Consequently, these positions of the switch are only applicable to A1-operation.

Meter ME102 reads the cathode current of the R.F. output stage (B104). The overall range of this meter is 200 mA.

In addition, there are test points 6 and 1,2 and 3 fitted beside tubes B6 and B101 to B103 respectively. The cathode current of these tubes can be measured at these test points.

PHYSICAL DESIGN

The complete transmitter is fitted on a chassis with a 19-in. front panel. Consequently, several of these transmitters can be fitted in a 19-in. standard cabinet.

There are four wall sockets at the rear of the cabinet and these sockets are used for connecting the mains voltage, the aerial, the variable frequency oscillator and the telephone line. The transmitter is controlled entirely from the front panel.

INSTALLING INSTRUCTIONS

1. Install the transmitter in a suitable room, where the transmitter can be connected to the mains, the aerial, the modulating line and to earth.
2. Connect the earth terminal at the back of the chassis to the earth circuit.
3. Connect the aerial cable to the socket marked "AERIAL" at the right-hand rear of the chassis, using a coaxial plug.
4. Using an 8-pole plug, connect the modulating line to the 8-pole socket at the left-hand rear of the chassis.
For the proper connection of this plug, consult the circuit diagram.
5. Using a 4-pole plug, connect the mains cable to the 4-pole socket. For the proper connection of this plug, consult the circuit diagram.
6. If a variable frequency oscillator is used, connect it to the coaxial socket at the back of the chassis in the centre, using a coaxial plug.
7. Make sure that all tubes and fuses have been inserted in the appropriate sockets and holders.
When the transmitter is connected to a 110 V A.C. mains, the fuse should have a value of 8 A, whilst the two series-connected primary windings of transformers T4 and T5 should be connected in parallel, as indicated in the circuit diagram.
8. Make sure that the correct crystals have been fitted in the holders.
These holders are behind the cover at the right-hand side of the front panel.

Note: The crystal frequency for the
 - 1.5 - 10 Mc/s range is 1x the carrier frequency,
 - 10 - 20 Mc/s range is $\frac{1}{2}$ x the carrier frequency,
 - 20 - 30 Mc/s range is $\frac{1}{3}$ x the carrier frequency.
9. Set the "CRYSTAL SWITCH" to the required position.
10. If a variable frequency oscillator is used, tune it to the required frequency between 1.5 Mc/s and 10 Mc/s (see the Note in item 8). In this case the "CRYSTAL SWITCH" should be set to the "EXTERN" position.
11. Set the "MAINS" switch to the "OFF" position and switch SK108 to the "ST.-BY" position.
12. Connect the transmitter to the mains, via an intermediate switch, or not, as the case may be, and switch on the mains voltage.
13. Make sure that the transmitting relay (RE4) can be energized from the remote control station. This should be possible if the direct voltage on the modulating line has a minimum value of 16 V and a maximum value of 48 V.

First alignment of the transmitter section

1. Make sure that the proper crystal has been fitted.
2. Set switch SK101 "CRYSTAL SWITCH" to the proper position.
3. Set switch SK108 "TRANSM. - ST.-BY - TUNE" to the "ST.-BY" position.
4. Set switch SK8 "MAINS" to the "ON" position.
5. Set the "RANGE" switch to the position for the frequency range in which the aerial frequency lies.
6. Set the pointer of the "GRID TUNING" control to approximately the aerial frequency on the lower scale.
7. Set the "AERIAL TUNING" control to the required position. This position is shown by a numeral beside this control. See the table below.

Position of "RANGE" switch	Aerial frequency in Mc/s	Numeral of "AERIAL TUNING" control
1	1.5 - 1.6	1
	1.7	2
	1.8	3
	1.9 - 2	4
	2 - 2.1	2
2	2.2	3
	2.3 - 2.5	4
	2.6 - 2.8	4
3	3	5
	3.5 - 4	6
	5	7
	5	5
	5.5 - 6	6
4	7	7
	8 - 9	8
	9.3 - 11	7
	12 - 17.5	8
	17 - 18	7
5	20 - 30	8

8. Set the metering switch at the lower left of the front panel to the "P.A. Ig" position.
9. Set the "DRIVE" control to the centre position.
10. Set switch SK108 "TRANSM. - ST.BY - TUNE" to the "TUNE" position.
The transmitter is now switched for reduced output power.
11. Using the "GRID TUNING" control, adjust the grid current to maximum reading of the meter. The reading of the meter should be approx. 5 mA (half scale). If necessary, use the "DRIVE" control to readjust.
12. Using the "ANODE TUNING" control, adjust the cathode current to minimum reading of the "CATHODE CURRENT P.A." meter.
13. Set switch SK108 "TRANSM. - ST.BY - TUNE" to the "TRANSM." position.
14. Turn the "AERIAL TUNING" control a little clockwise (tighter coupling) and repeat the instructions in items 11 and 12 until the maximum grid current coincides with the minimum cathode current.
15. Repeat item 14 until the minimum cathode current is approx. 8.5 scale divisions.
At this reading (= 170 mA cathode current) the output power is approx. 50 W at a low-reactance load of approx. 50 ohms.
16. If the crystal frequency has to be readjusted, this may be done with the help of capacitors C147 to C152. These capacitors are on the chassis behind the crystal holders.
17. Set switch SK108 "TRANSM. - ST.BY - TUNE" to the "ST.-BY" position. Only filament voltage is now being applied to the transmitter, which is ready for immediate use.

First alignment of the modulator section

1. Set the metering switch to the "Ik MOD." position.
2. Set switch SK108 "TRANSM. - ST.BY - TUNE" to the "TRANSM." position.
3. Set the "MODULATOR" control (R32) on the front panel to the minimum position (completely counter-clockwise).
4. Connect the deflection plates of a CRT-oscilloscope (e.g. Philips type GM 5654 or GM5660) to the aerial by means of a capacitive or an inductive coupling.
5. Apply an A.F. signal of approx. 1000 c/s and a strength of approx. 0.2 V to the line input.
6. The current values in tables I and II are given for testing the cathode currents of amplifier tube B6 and push-pull output tube B7.
7. Make the oscilloscope ready for use, so that a useful image of the carrier is shown.
8. Turn the "MODULATOR" control clockwise until the required depth of modulation is made visible on the oscilloscope. A depth of modulation of 90% is reached if the ratio between the maximum amplitude and the minimum amplitude of the carrier is 20 : 1.
9. Discontinue the A.F. signal and make use of the microphone circuit. The effect and the depth of modulation can now be seen on the oscilloscope screen and, if necessary, corrections may be made with the "MODULATOR" control.
10. Disconnect the oscilloscope. The transmitter is ready for operation and control from the remote control station.

DAILY OPERATION

a. Switching on

1. Make sure that the "MAINS" switch is at the "ON" position (the connection to the 220 V mains is signalled by the red lamp on the front panel).
2. Make sure that the D.C. source (for energizing the transmitting relay) has been switched on from the remote control station.
3. Do not use the transmitter for approx. 1 minute after it has been switched on. The tubes can thus reach their operating temperature without being loaded.
4. Set switch SK108 "TRANSM. - ST.-BY - TUNE" to the "ST.-BY" position.

b. Transmitting

1. Make sure that the microphone and the push-to-talk switch have been connected to the circuit as required.
2. Operate the push-to-talk switch and speak into the microphone.
3. The transmitter is returned to the "ST.-BY" condition when the push-to-talk switch is released.

c. Switching off

1. When the transmitter is in the "ST.-BY" condition, it can be switched off completely by setting the "MAINS" switch to the "OFF" position. (The red lamp on the front panel goes out).
2. Switch off the D.C. source (which is used for energizing the transmitting relay).

TEST DATA

a. Continuity testing

1. Set the "MAINS" switch of the transmitter to the "OFF" position.
2. Remove the mains plug (ST1) and the line plug (ST2) from the back of the chassis.
3. Set the "MAINS" switch to the "ON" position.
4. Make the following tests with the help of an ohmmeter.

<u>Measure between</u>	<u>notes</u>	<u>ohms</u>
ST1 1 and 2	for 220 V mains	10.5
ST1 1 and 2	for 220 V mains, transmitting relay energized	1.5
ST1 1 and 2	for 110 V mains	2.6
ST1 1 and 2	for 110 V mains, transmitting relay energized	0.4
ST1 1 and chassis		infinite
ST1 1 and chassis	transmitting relay energized	infinite
ST1 2 and chassis		infinite
ST1 2 and chassis	transm. relay energized	infinite
ST2 2 and 3		36
ST2 2 and chassis		2200
ST2 3 and chassis		2200
ST2 6 and chassis		2200

5. Set the "MAINS" switch to the "OFF" position and refit the two plugs (ST1 and ST2).

b. Voltage testing

1. Set the "MAINS" switch to the "ON" position.
2. Set switch SK108 "TRANSM. - ST.BY - TUNE" to the "TRANSM." position.
3. Use an AVO-8 meter (20,000 ohms/V) for the following measurements; deviations of $\pm 15\%$ may occur between the chassis and:

<u>Test point</u>	<u>notes</u>	<u>voltage</u>
C58		-33 V
R52	top of potentiometer	-47 V
R52	wiper of potentiometer	-30 V

<u>Test points</u>	<u>notes</u>	<u>voltage</u>
tube B7 (g2)		+300 V
transformer T3 (terminal 5)		+610 V

The following voltages may show deviations of +30% between the chassis and:

<u>Test point</u>	<u>notes</u>	<u>voltage</u>
tube B101(cathode)		+0.7 V
tube B101 (screen grid)		+32 V
tube B101 (anode)		+300 V
tube B102 (cathode)		+10 V
tube B102 (screen grid)		+265 V
tube B102 (anode)		+300 V
tube B103 (cathode)	normal operation	+3.5 V
tube B103 (screen grid)	DRIVE min.	+30 V
tube B103 (screen grid)	DRIVE max.	+250 V
tube B103 (screen grid)	DRIVE normal oper.	+175 V
tube B103 (anode)		+300 V
tube B104 (cathode)		+1.00 V
junction L107/108		-43 V
tube B104 (anodes)		+580 V
tube B104 (screen grid)		+255 V
tube B104 (screen grid)	switch pos. "TUNE"	+30 V
tube B6 (cathode)		+6.5 V
tube B6 (screen grid)		+230 V
tube B6 (anode)		+230 V
tube B7 (both screen grids)		-30 V
tube B7 (screen grid)		+270 V
tube B7 (anodes)		+550 V
MP1		+0.65 V
MP2		+0.65 V
MP3		+0.65 V
MP6		+0.65 V

4. The following measurements are carried out on a transmitter which is 90% modulated with 1000 c/s. The measurements are made by means of a diode voltmeter (e.g. Philips type GM 6004) which is connected between the chassis and the test points listed on the next page:

<u>Test point</u>	<u>voltage</u>
tube B6 (control grid)	3 V~
tube B6 (anode)	90 V~
tube B7 (both control grids)	18 V~
tubes B101, B102, B103, B104, B6, B7 (filam.volt)	6.3 V~
tubes B8, B9, B10	5 V~

TABLE I

Meter readings for positions 1 to 7 of meter ME101, transmitter unmodulated

<u>Position</u>	<u>minimum</u>	<u>nominal</u>	<u>maximum</u>	<u>range of meter</u>
1 P.A. Ig	2.5	5	7.5	10 mA
2 I.ANT		3-8		
3 C.W.				
4 PHONE				
5 I ANT		3-8		10 mA
6 P.A. Ig	2.5	5	7.5	
7 Ik MOD.	0.5	1	1.5	

TABLE II

As table I, but at 90% modulation of the transmitter

<u>Position</u>	<u>minimum</u>	<u>nominal</u>	<u>maximum</u>	<u>range of meter</u>
1 P.A. Ig	2.5	5	7.5	10 mA
2 I ANT.		3-8		
3 C.W.				
4 PHONE				
5 I ANT.		3-8		10 mA
6 P.A. Ig	2.5	5	7.5	
7 Ik MOD	4	5	6	

TABLE III

Reading of meter ME102 ("CATHODE CURRENT P.A.")

	<u>meter reading</u>	<u>range of meter</u>
unmodulated	8.5 (approx. 50 W)	200 mA
90% modulated	7.5 - 8.5	200 mA

PARTS LIST

<u>Ref.no.</u>	<u>Technical data</u>	<u>Maker</u>	<u>Ph.-order code</u>
B6		Ph.	E 80 L
B7		Ph.	QQE 06/40
B8-B10		Ph.	GZ 34
B101-B103		Ph.	E 80 L
B104		Ph.	QQE 06/40
G32	100 nF \pm 10%; 630 V	E.R.	OD 770 02/A100K
C33	470 nF \pm 10%; 400 V	E.R.	OD 770 06/A470K
C34-C35	100 nF \pm 10%; 1000 V	E.R.	OD 770 08/A100K
C36	4,7 nF \pm 20%; 1000 V	E.R.	OD 770 03/P4K7
C37-C38	2,2 nF +50-10%; 250 V	Ph.	C 301 BA/H2K2
C39		PTI	
C40		PTI	
C41 (two in par.)	2,7 pF \pm 1/2%; 500 V	Ph.	C 304 GB/L2E7
C42	47 pF \pm 5%; 500 V	Ph.	48 336 05/47E
C43	1 nF 500 V	Ph.	NE 700 99
C51	6 μ F 1000 V	Ph.	48 115 10/V6M
C52A-C52B	6 μ F 1000 V	Ph.	48 115 10/V6M
C53-C54	6 μ F \pm 20%; 500 V	Ph.	C 112 BC/P6M
C55-C56	10 μ F \pm 20%; 500 V	Ph.	C 112 BC/P10M
C57	64 μ F +50-10%; 25 V	Ph.	C 435 AL/F64
C58	64 μ F +50-10%; 50 V	Ph.	C 435 AL/H64
C59	6 μ F 1000 V	Ph.	48 115 10/V6M
C100	6 nF 500 V	Ph.	OD 778 06
C101	33 pF \pm 5%; 500 V	Ph.	48 336 99/33E
C102	1,8 nF \pm 5%; 500 V	Ph.	48 336 01/1K8
C103	10 nF +50-20%; 300 V	Ph.	B1 664 40
C104	1,8 nF \pm 5%; 500 V	Ph.	48 336 05/1K8
C105	100 pF \pm 5%; 500 V	Ph.	48 336 05/100E
C106	10 nF +50-20%; 300 V	Ph.	B1 664 40
C107	1,8 nF \pm 5%; 500 V	Ph.	48 336 05/1K8
C108	47 pF \pm 5%; 500 V	Ph.	48 336 05/47E
C109	1,8 nF \pm 5%; 500 V	Ph.	48 336 05/1K8
C110-C111	220 pF \pm 5%; 500 V	Ph.	48 336 05/220E
C112	1,8 nF \pm 5%; 500 V	Ph.	48 336 05/1K8

<u>Ref. no.</u>	<u>Technical data</u>	<u>Maker</u>	<u>Ph.-order code</u>
C113	220 pF \pm 5%; 500 V	Ph.	48 336 05/220E
C114	1,8 nF \pm 5%; 500 V	Ph.	48 336 05/1K8
C115-C116	220 pF \pm 5%; 500 V	Ph.	48 336 05/220E
C117	10-160 pF	Volt	NT 120 21
C119	1,8 nF \pm 5%; 500 V	Ph.	48 336 05/1K8
C120	1 nF \pm 5%; 500 V	Ph.	48 336 01/1K
C121	1-8 pF	PTI	
C122-C123	1 nF \pm 20%; 3000 V	Ros.	NA 002 82
C124-C126	10-110 pF 1500 V	Volt	NT 120 20
C127-C128	100 pF \pm 20%; 2000 V	Ros.	NA 002 80
C129	500 pF	Volt	XB 000 69
C130	160 pF \pm 1%; 500 V	Ph.	48 336 01/160E
	180 pF \pm 1%; 500 V connected in parallel	Ph.	48 336 01/180E
C131-C133	470 pF \pm 5%; 500 V	Ph.	48 336 05/470E
C134-C137	1,8 nF \pm 5%; 500 V	Ph.	48 336 05/1K8
C138	10 nF \pm 50-20%; 300 V	Ph.	B1 664 40
C139	1,8 nF \pm 5%; 500 V	Ph.	48 336 05/1K8
C140-C142	470 pF \pm 5%; 500 V	Ph.	48 336 05/470E
C143-C144	100 pF \pm 5%; 500 V	Ph.	48 336 05/100E
C145-C146	1 nF \pm 5%; 500 V	Ph.	48 336 05/1K
C147-C152	5-25 pF 150 V	Volt	NT 120 18
GR1		Ph.	OA 73
GR2		WESTH	OD 699 29
GR3		WESTH	NQ 165 18
KL101		PTI	NY 800 50/04
KL102		PTI	NY 800 53/04
KT1-KT6	as stated in the order		
L18		PTI	NE 567 71
L20	4,5 H	PTI	NQ 270 42
L21	8 H	PTI	NQ 270 41
L22	4,5 H	PTI	NQ 270 02
L99-L100	47 μ H	PTI	NE 633 54
L101	1 mH	PTI	NE 633 62

<u>Ref. no.</u>	<u>Technical data</u>	<u>Maker</u>	<u>Ph.-order code</u>
L102	470 μ H	PTI	NE 633 60
L103	10-14 μ H	PTI	NT 095 56
L104	1 mH	PTI	NE 633 62
L105		PTI	NT 095 54
L106		PTI	NT 095 53
L107-L108		PTI	NT 403 94
L109-L110	1 mH	PTI	NT 633 62
L111		PTI	NT 402 22
L112		PTI	NE 617 16
L113		PTI	NT 095 51
L114		PTI	NT 095 52
L115		PTI	NT 095 55
L116-L117	15 μ H	PTI	NT 095 57
L118	4,7 mH	PTI	NE 633 66
LA1		Ph.	D 114 07/00/100mA/ 6,3 V/TB6
M101-M102	1 mA/100 mV	Ph.	P 809 47
R21	5,6 k Ω \pm 5%; 1/2 W	Ph.	B8 305 06B/5K6
R32	100 k Ω	Ph.	NT 117 23
R33	22 k Ω \pm 5%; 1/2 W	Ph.	B8 305 06B/22K
R34	1 k Ω \pm 5%; 1/2 W	Ph.	B8 305 06B/1K
R35	120 k Ω \pm 5%; 1/2 W	Ph.	B8 305 14B/120K
R36 (two)	470 Ω \pm 5%; 1/2 W	Ph.	B8 305 06B/470E
R37	27 Ω \pm 5%; 1/2 W	Ph.	B8 305 06B/27E
R38	1 k Ω \pm 5%; 1/2 W	Ph.	B8 305 06B/1K
R39	10 k Ω \pm 5%; 1/2 W	Ph.	B8 305 06B/10K
R40	15 k Ω \pm 5%; 8 W	Ph.	48 766 05/15K
R41	33 Ω \pm 5%; 1/2 W	Ph.	B8 305 06B/33E
R42-R43	3,3 k Ω \pm 5%; 1/2 W	Ph.	B8 305 06B/3K3
R44	33 Ω \pm 5%; 1/2 W	Ph.	B8 305 06B/33E
R45	15 k Ω \pm 5%; 8 W	Ph.	48 766 05/15K
R46	5 Ω \pm 1%; 0,4 W	Ph.	48 760 01/5E
R51	330 Ω \pm 10%; 1 W	Ph.	B8 305 07A/330E
R52	10 k Ω \pm 10%; 3 W	Colv.	OD 736 36
R53	1,2 k Ω \pm 5%; 8 W	Ph.	48 766 05/1K2

<u>Ref. no.</u>	<u>Technical data</u>	<u>Maker</u>	<u>Ph.-order code</u>
R54	220 kΩ ± 5%; 2 W	Ph.	B8 305 16B/220K
R57	22 Ω ± 5%; 10 W	Ph.	48 767 05/22E
R100	56 Ω ± 5%; 1/2 W	Ph.	B8 305 06B/56E
R101	47 kΩ ± 5%; 1/2 W	Ph.	B8 305 06B/47K
R102	10 kΩ ± 5%; 1/2 W ²	Ph.	B8 305 06B/10K
R103	820 kΩ ± 5%; 1/2 W	Ph.	B8 305 14B/820K
R104	1,5 kΩ ± 5%; 1/2 W	Ph.	B8 305 06B/1K5
R105	100 kΩ ± 5%; 1/2 W	Ph.	B8 305 06B/100K
R106	10 kΩ ± 5%; 1/2 W	Ph.	B8 305 06B/10K
R107	100 kΩ ± 5%; 1/2 W	Ph.	B8 305 06B/100K
R108	330 Ω ± 5%; 1/2 W	Ph.	B8 305 06B/330E
R109	10 kΩ ± 10%; 1 W	Ph.	B8 305 07A/10K
R110	100 Ω ± 5%; 1/2 W	Ph.	B8 305 06B/100E
R111	22 kΩ ± 5%; 1/2 W	Ph.	B8 305 06B/22K
R112	270 Ω ± 5%; 1/2 W	Ph.	B8 305 06B/270E
R113	68 Ω ± 5%; 1/2 W	Ph.	B8 305 06B/68E
R114	1 kΩ ± 10%; 1 W	Ph.	B8 305 07A/1K
R115	25 kΩ ± 10%; 1 W	Colv.	OD 736 48
R116	100 Ω ± 5%; 1/2 W	Ph.	B8 305 06B/100E
R117	220 Ω ± 5%; 2 W	Ph.	B8 305 08B/220E
R118	111,1 Ω ± 1%; 0,4 W	Ph.	48 760 01/111E1
R119-R120	100 Ω ± 5%; 1/2 W	Ph.	B8 305 06B/100E
R121	4,9 Ω ± 1%; 0,4 W	Ph.	48 760 01/4E9
R122	100 Ω ± 10%; 1 W	Ph.	B8 305 07B/100E
R123	82 Ω ± 5%; 8 W	Ph.	48 766 05/82E
R124	33 kΩ ± 5%; 10 W	Ph.	48 767 05/33K
R125	910 Ω ± 1%; 0,6 W	Ph.	48 064 01/910E
R126	270 Ω ± 5%; 1/2 W	Ph.	B8 305 06B/270E
R127	27 Ω ± 5%; 1/2 W	Ph.	B8 305 06B/27E
R128	33 kΩ ± 5%; 1/2 W	Ph.	B8 305 06B/33K
R129	910 Ω ± 1%; 0,6 W	Ph.	48 064 01/910E
R130-R131	4,7 kΩ ± 5%; 1 W	Ph.	B8 305 07B/4K7
R132-R133	47 kΩ ± 10%; 1 W	Ph.	B8 305 07A/47K
R134	10 kΩ ± 5%; 1/2 W	Ph.	B8 305 06B/10K
RE4	8 mA	PTI	SZS 117/100/a

<u>Ref. no.</u>	<u>Technical data</u>	<u>Maker</u>	<u>Ph.-order code</u>
RE102	24 V	Haller	OD 921 60
SK8		PTI	OD 903 56
SK101		PTI	NT 180 33
SK104		PTI	NE 665 06
SK105		PTI	NE 664 95
SK106-SK107		PTI	NE 663 35
SK108		PTI	OD 932 81
SK109		PTI	NE 663 34
SK111		PTI	NT 180 34
SK112		PTI	NE 663 32
T1		PTI	NE 567 96
T2		PTI	NE 567 71
T3		PTI	NE 567 65
T4		PTI	NQ 281 65
T5		PTI	NQ 281 67
VL1 or	4 A/220 V	Olvis	08 142 34
VL2	8 A/110 V	Olvis	OD 761 10
	VL1 and VL2 depend on the mains voltage		
VL3	160 mA	Olvis	08 141 50

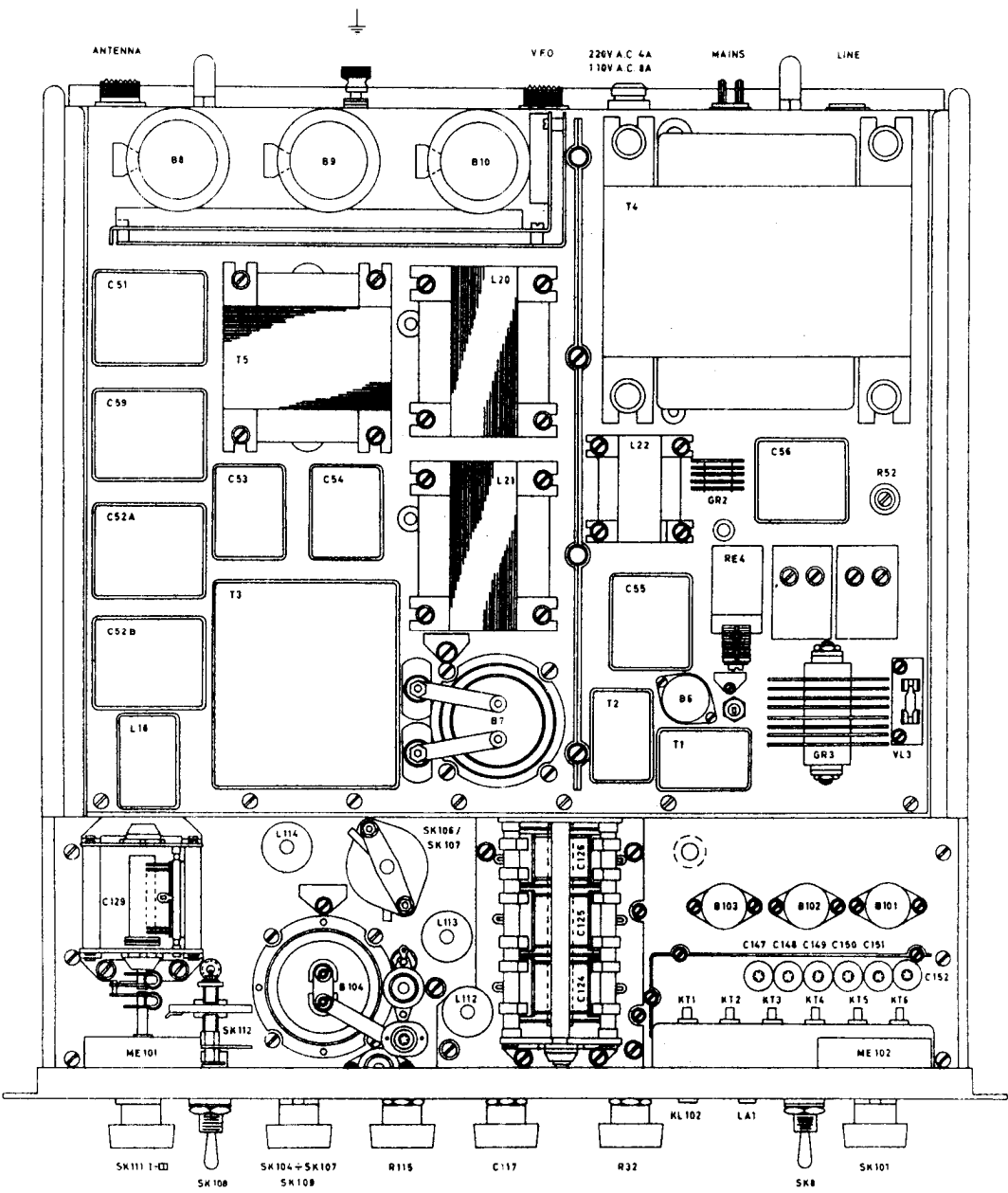
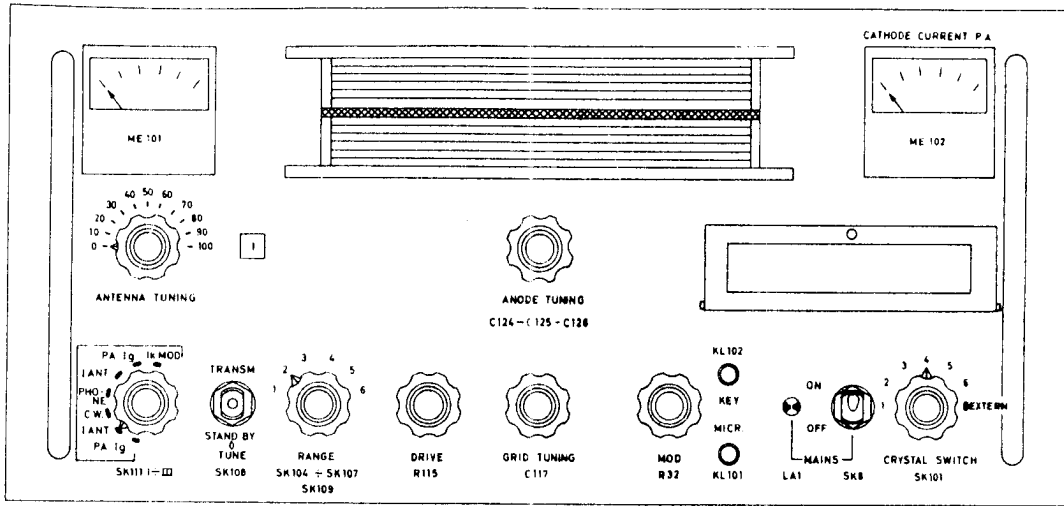

1.5 - 10 MHz OSC But

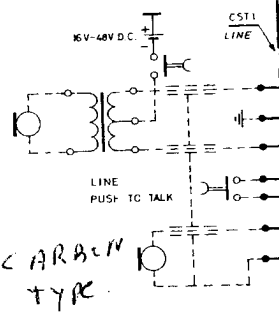
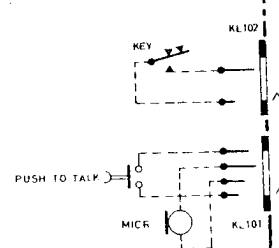
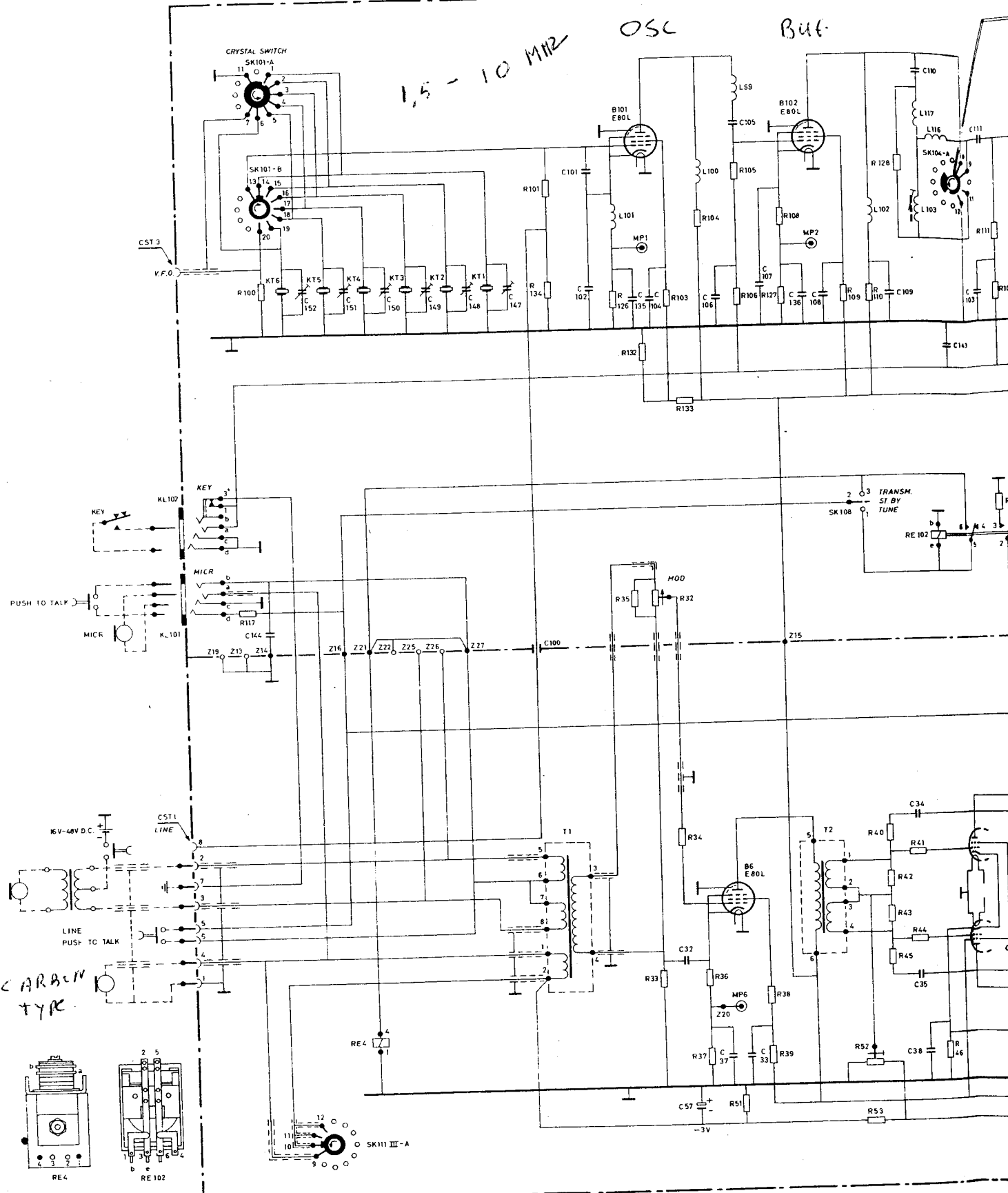

CARBON TYR.

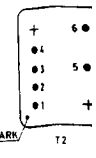
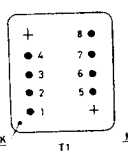
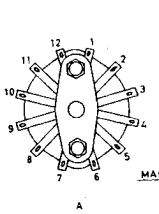
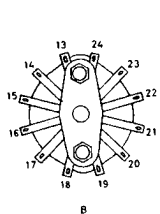
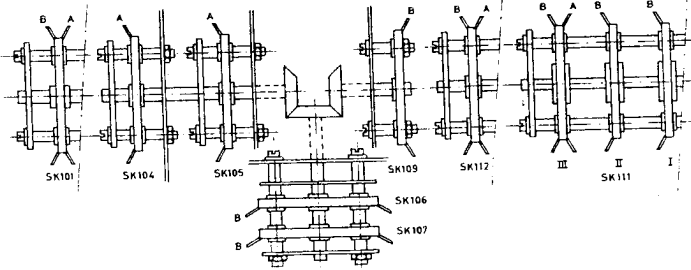
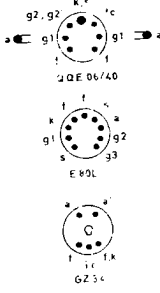
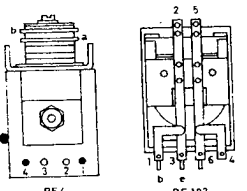

multiplier

RANGE PA

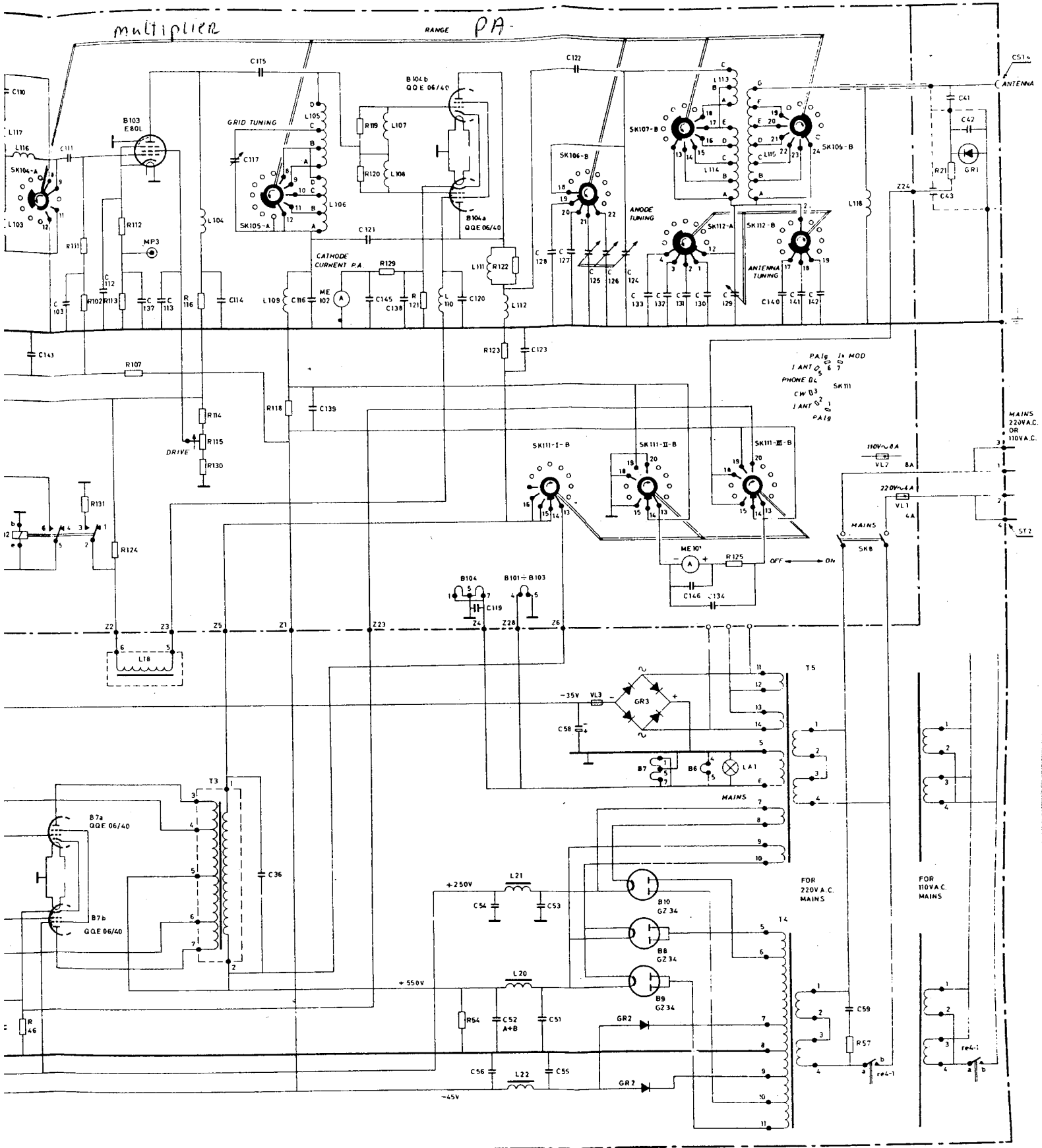

PA10 In MOD
 I ANT 5 6 7
 PHONE Dc SK111
 CW D3
 I ANT 1 2 3
 PA19

MAINS
 220V AC
 OR
 110V AC

110V-8A
 VL7 8A

220V-4A
 VL1 4A

MAINS

OFF ON

SK8

T5

GR3

B7

B6

LA1

MAINS

FOR 220V A.C. MAINS

FOR 110V A.C. MAINS

C59

R57

rel-1

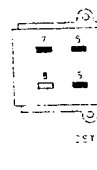
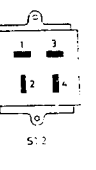
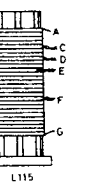
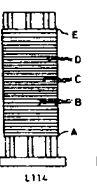
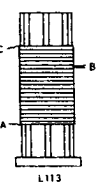
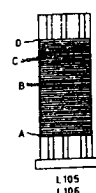
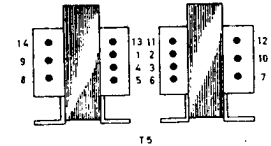
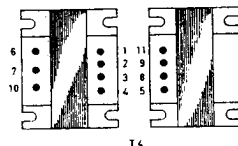
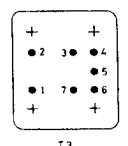
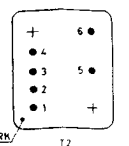

50W HF TRANSMITTER
 N° DB-R1055e/1-1/626921

SFZ 395/00

NV PHILIPS' TELECOMMUNICATIE INDUSTRIE - Copyright reserved